



WORLD'S FASTEST WATERJET



KMT WATERJET PARTS CATALOG



Genuine Parts

Your business is worth it.

FALL 2016



KMT Genuine Parts Your business is worth it.

Over 40 years ago the very first commercial installation of a waterjet cutting system began operation using a KMT intensifier. Since then, KMT pumps with KMT Genuine Parts have served customers reliably across many industries, including yours.

KMT Genuine Parts are manufactured in the USA to the exact standards as the original parts found on new KMT pumps. Our expertise and operating experience extends from the original SL-I operating at 3,800 bar all the way to today's industry-leading KMT PRO pumps cutting at 6,200 bar. No other provider has this breadth of experience and you can rest assured that your KMT pump will operate at peak performance when you use KMT Genuine Parts.

Benefits of KMT Genuine Parts:

- **Robust quality control inspection process to ensure superior fit and durability**
- **Manufactured to precise specifications best suited for your KMT pump**
- **Improvements made to KMT pumps are incorporated into KMT Genuine Parts**
- **KMT Customer Service and Technical Support is available 24/7**

Remember to use KMT Genuine Parts to maintain your pump warranty and ensure that your investment pays off over the long-term. The use of imitation parts will void warranty coverage, compromises safety and may result in reduced component lifetime.

Decades of precision manufacturing and engineering experience, proprietary manufacturing processes and patented technology make KMT Genuine Parts an exceptional value - your business is worth it.

Contents

Topworks Parts 5

Seal Assemblies	7
Cylinder Seal Assemblies	8
Repair Kits	8
Proximity Switch Kits	9
Hydraulic Cylinders & Heads	10
Pump Plungers	11
Liners	12
Backup Rings	13
Hydraulic Cartridge Seal Assemblies	13
Hydraulic Piston Assemblies	14
Cylinders	15
High Pressure Cylinder Nuts	16
Bushing Retainer Flanges	17
Retaining Rings	17
Miscellaneous	17

Sealing Heads 19

Sealing Head Assemblies	20
Sealing Heads	22
Seal Assemblies	23
Glands	23
Spacers	23
Repair Kits	24

Cutting Heads 27

Cutting Head Assemblies	28
Cutting Heads	29

Cutting Head Parts 31

AUTOLINE Cutting Head Assembly Components	32
Cap	33
Body	33
Wear Inserts	34
Spare Parts Kits	34
Abrasive Feed Tube Adapters	35

Abrasive Feed Tube Assembly	35
Knob Retainer	35
Abrasive Guard	35
IDE Retaining Nut	36
Focusing Tube Retaining Collet	36
Short Stop Adapter Assembly	36

Orifices & Focusing Tubes 37

Orifices for Pure Water Cutting	38
Foodgrade™ Orifices for Pure Water Cutting	40
Orifices for Abrasive Cutting	41
Focusing Tubes	43

Pneumatic Valves 45

Pneumatic Valve / Actuator Assemblies	46
Repair Kits	47
Tool Kits	48
Pneumatic Valve Bodies	48
Actuators	49
Backup Rings	50
Nozzle Nuts	50
Torque Wrench for Nozzle Nuts	50
Valve Glands	51
Nozzle Tubes	52

Fittings & Tubing 55

High Pressure Tubing	56
High Pressure Tubing - Accessories	58
High Pressure Fittings	59
Check Valves	65
Inline Water Filters	66
HP Water Filter Assemblies	67
Swivel Joints	68
Swivel Joints - Cap Assemblies	68



Swivel Joints - Straight Bodies	68
Swivel Joints - Spindles	69
Swivel Joints - Straights	69
90 Degree Bodies	70
Bushings	70
Thrust Bearings	70
Seal Assemblies	71
Repair & Tool Kits	72
Coning & Threading Tool Kits	73
Coning Tool Assemblies	73
Threading Tool Assemblies	74
Coning & Threading	74
Hand Coning & Threading Tool Kit "Small Blade"	75
Hand Coning & Threading Tool Assemblies	75
Hand Coning & Threading	76

Miscellaneous 77

LP Water Filter Components	78
Hydraulic Oil Filter Components	78
O-Rings for Sealing Heads	79
O-Rings for Pneumatic Valves	79
O-Rings for Topworks	80
O-Rings for Cutting Heads	82
O-Rings for Inline Filters	83
Booster Pumps	83
Hoses	83
Gauges	84
Proximity Switch Kits	84
Electrical Components	85
Light Bulbs	86
Pressure Transducers	86
Topworks Tools	87
Lubricants	89

Your notes 90

Your contact 91

Index 92



www.kmt-partsline.com

The **PARTSLINE Anywhere online spare parts catalogue** enables KMT customers to identify the original spare parts they need at any time and from anywhere in the world, thus simplifying the problem-free order process via our customer service.

For further details see **contact information on page 91** of this catalog or send us an e-mail at

order.spares@kmt-waterjet.com

For your convenience, we have labeled all items in this catalog according to the pressure range of their application. The following color code applies:

- The product has been designed for use with our high performance **PRO product series** and is applicable at a pressure range of up to 6,200 bar (90,000 psi).
- The product is applicable at a pressure range of up to 4,100 bar (60,000 psi).

All dimensions in this catalog are in inch unless specified otherwise. The decimal notation can be converted as follows:

- 0.25 = 1/4 inch
- 0.38 = 3/8 inch
- 0.56 = 9/16 inch
- 0.75 = 3/4 inch

Please note that all technical details shown in this catalog are subject to change and pictures are similar.





Topworks Replacement Parts



THE KMT TOPWORKS - THE SOURCE OF PRESSURE

**NO OTHER SYSTEM INCORPORATES THE FEATURES OF
KMT INTENSIFIERS TO DELIVER THE SIMPLEST, EASIEST-TO-
OPERATE, MOST RELIABLE SYSTEM.**



The KMT intensifier is the heart of your waterjet system and helps determine the quality and quantity of the products you make. The use of KMT Genuine Parts to maintain your intensifier helps maximize life and improves value.

KMT PRO® replacement parts are available exclusively from KMT and require precision manufacturing to ensure the best performance from your PRO® pump.

The KMT Intensifier Features:

- **Plunger - KMT intensifiers use a longer pressurizing stroke than other manufacturers, thereby stroking less frequently for longer life.**
- **Seals - KMT's Hyperlife™ seals (U.S. Patent #6,769,695 and Sweden Patent #0203660-6) used in the Streamline topworks provides greater value than inferior, imitation parts.**
- **Metal-to-Metal Seal Head - Ensures positive sealing and the ability to re-use crucial components.**

SEAL ASSEMBLIES

DESCRIPTION

PART No.

- **UHP Seal Assembly - SUPRAlife**
 6,200 bar
 Used on PRO-III units with a 60 or 125 horsepower rating
- **UHP Seal Assembly - 0.88 plunger units**
 6,200 bar
 Used on PRO-I and PRO-2 units with a 60 or 125 horsepower rating
- **HP Seal Assembly - 1.13 plunger units**
 4,100 bar
 Used on all SL-V and SL-VI units with a 75 to 200 horsepower rating
- **HP Seal Assembly - 1.13 plunger units, hybrid**
 4,100 bar
 Used on all SL-V units with a 75 to 200 horsepower rating
- **HP Seal Assembly - 0.88 plunger units**
 3,800/4,100 bar
 Used on all SL-V and SL-VI units with a 15 to 60 horsepower rating
- **HP Seal Assembly - 0.88 plunger units**
 3,800/4,100 bar
 Used on SL-IV Plus flange units & SL-V HSEC units
- **HP Seal Assembly - 0.88 plunger units**
 3,800 bar
 Used on all SL-IV units

72158494

20479499

05149711

20467135

20422243

05149703

05123385

CYLINDER SEAL ASSEMBLIES

DESCRIPTION

PART No.

HP Cylinder Seal Assembly

3,800 bar
Used on all SL-IV units

05027172



REPAIR KITS

Repair Kit - Hydraulic Piston PRO

Kit includes retaining rings, bearings, o-rings, backup rings, seal assembly and check valves.

Repair Kit PRO-III

72168337

Repair Kit PRO-2

05221951

Repair Kit PRO-1

05221943



Repair Kit - Hydraulic Piston, 1.13 plunger units.

3,800/4,100 bar. Used on all SL-V and SL-VI units with a 75 to 200 horsepower rating. Kit includes retaining rings, bearings, o-rings, backup rings, seal assembly and check valves.

80085079



Repair Kit - Hydraulic Piston, 0.88 plunger units.

3,800/4,100 bar. Used on all SL-V and SL-VI units with a 15 to 60 horsepower rating. Kit includes retaining rings, bearings, o-rings, backup rings, seal assembly and check valves.

05115951



Repair Kit - HP Cylinder Assembly

Used on SL-IV, 3,800 bar. Kit includes seals, o-rings and backup rings to repair the HP cylinder seal and the sealing head seal.

05115977



* Available on request

PROXIMITY SWITCH KITS

DESCRIPTION

PART No.

 **Proximity Switch Kit SL-VI**
3,800 - 4,100 bar
Used on all SL-VI units with a 15 to 50 horsepower rating

72146433



 **Proximity Switch Kit - E50**
3,800 - 4,100 bar
Used on all SL-IV, SL-V, Classic and OEM units with a 15 to 60 horsepower rating
Replaces Part #05127584

20453934



 **Proximity Switch Kit SL-VI**
Used on all SL-VI units with a 100-200 horsepower rating
Used on all 6,200 bar PRO units

72141569



 **Proximity Switch Kit**
Used on all SL-IV and SL-V units with a 75-200 horsepower rating
Used on 6,200 bar PRO-I and PRO-2 units

20453925



DESCRIPTION

PART No.

■ **Hydraulic Cylinder, 0.88 plunger HSEC units**

3,800/4,100 bar
Used on all SL-IV, SL-V, Classic and OEM units with a 15 to 60 horsepower rating

05034764



■ **Hydraulic Cylinder, 1.13 plunger HSEC units**

3,800/4,100 bar
Used on all SL-V units with a 75 to 200 horsepower rating and PRO units with a horsepower rating of 60 or 125

05144514



■ **Hydraulic Cylinder Head, 0.88 plunger, HSEC units**

3,800 bar
Used on all Classic units with a 30 or 50 horsepower rating

20414880



■ **Hydraulic Cylinder Head, 0.88 plunger, HSEC units**

4,100 bar
Used on all SL-IV, SL-V and OEM units with a 15 to 60 horsepower rating

05034772



■ **Hydraulic Cylinder Head, 1.13 plunger, HSEC units**

4,100 bar
Used on all SL-V units with a 75 to 200 horsepower rating

20416445



PUMP PLUNGERS

DESCRIPTION

PART No.

 **Ceramic Plunger - 0.88 plunger units**
6,200 bar
Used on all PRO-III units

72162253

Photo not available

 **Ceramic Plunger - 0.88 plunger units**
6,200 bar
Used on all SL-VI PRO units

72138164



 **Ceramic Plunger - 0.88 plunger units**
4,100/6,200 bar
Used on all SL-V and SL-VI units with a 15 to 60 horsepower rating and on all PRO-I and PRO-2 units

05119151



 **Ceramic Plunger - 1.13 plunger units**
4,100 bar
Used on all SL-V and SL-VI units with a 75 to 200 Horsepower rating

05144506



 **Carbide Plunger, 0.88 plunger units**
3,800 bar
Used on all Classic and NL-I units with a 30 to 50 horsepower rating.

05039771



DESCRIPTION

PART No.

- **Liner - UHP Cylinder, 0.88 plunger units**
 6,200 bar
 Used on all PRO-III with a 60 or 125 horsepower rating
- **Liner - UHP Cylinder, 0.88 plunger units**
 6,200 bar
 Used on all PRO-I and PRO-2 units with a 60 or 125 horsepower rating
- **Liner - HP Cylinder, 1.13 plunger units**
 4,100 bar
 Used on all SL-V and SL-VI units with a 75 to 200 Horsepower rating
- **Liner - HP Cylinder 0.88 plunger units**
 4,100 bar
- **Liner - HP Cylinder, 0.88 plunger units, Brass**
 4,100 bar

72163802



20474333



72110945



20497767



20491603



* Available on request

BACKUP RINGS

DESCRIPTION

PART No.



Hydraulic Piston Assembly

4,100/6,200 bar
 Used on SL-IV, SL-V & OEM 7/8" plunger units with a 15 to 60 horsepower rating and PRO units with a horsepower rating of 60 or 125

05049994



5.25 x 5.50, 1.13 plunger units

4,100/6,200 bar
 Used on all SL-V and SL-VI (PRO) units with a 75 to 200 Horsepower rating

05120092



3.75 x 4.0, 0.88 plunger units

3,800/4,100 bar
 Used on all SL-IV, SL-V and SL-VI units with a 15 to 60 horsepower rating.

05034855



HYDRAULIC CARTRIDGE SEAL ASSEMBLIES



0.88 plunger units

4,100/6,200 bar
 Used on all SL-IV, SL-V and SL-VI units with a 15 to 60 horsepower rating and all PRO units with a 60 or 125 Horsepower rating

05130091



1.13 plunger units

4,100 bar
 Used on all SL-V and SL-VI units with a 75 to 200 Horsepower rating

05146584



0.88 plunger units

3,800 bar
 Used on all Classic units with a 30 or 50 horsepower rating & NEOLINE 40 units

80086622



DESCRIPTION

PART No.

■ 1.13 plunger units

3,800/4,100 bar
Used on all SL-V units with a 75 to 200 horsepower rating
Kit includes piston, retaining rings, bearings, o-rings, backup rings, seal assembly and check valves

05146576



■ 0.88 plunger units

3,800/4,100 bar
Used on all SL-IV, SL-V, Classic and OEM units with a 15 to 60 horsepower rating
Kit includes piston, retaining rings, bearings, o-rings, backup rings, seal assembly and check valves

05132253

■ Seal Assembly - Hydraulic Piston, 0.88 plunger units

3,800/4,100 bar
Used on all SL-V, Classic and OEM units with a 15 to 60 horsepower rating

05117965



■ Bearing - Hydraulic Piston, 0.88 plunger units

3,800/4,100 bar
Used on all SL-V, Classic and OEM units with a 15 to 60 horsepower rating

05117940



DESCRIPTION

PART No.

- PRO-III Cylinder - 0.88 plunger units**
 6,200 bar
 Used on all PRO-III units with a 60 or 125 horsepower rating
- PRO-2 Cylinder - 0.88 plunger units**
 6,200 bar
 Used on all PRO-2 and SL-VI PRO units with a 60 or 125 horsepower rating
- PRO-I Cylinder - 0.88 plunger units**
 6,200 bar
 Used on all PRO-I units with a 60 or 125 horsepower rating
Replaces Part #20473479 & #20431076
- Cylinder - 1.13 plunger HSEC-C**
 4,100 bar
 Used on all SL-VI units with a 100 to 200 horsepower rating
- Cylinder - 1.13 plunger HSEC**
 4,100 bar
 Used on all SL-V units with a 75 to 200 horsepower rating
Replaces Part #20473479 & #20431076
- Cylinder - 0.88 plunger HSEC-C**
 4,100 bar
 Used on all SL-VI units with a 15 to 50 horsepower rating
- Cylinder - 0.88 plunger HSEC**
 4,100 bar
 Used on all SL-V and OEM units with a 15 to 60 horsepower rating
Replaces Part #20479503 & #05144647

72166738



72121858



72121850



72154588



72119536



72160831



72119544

DESCRIPTION

- 0.88 plunger**
 3,800 bar
 Used on SL-IV SSEC and NL-I units

- 0.88 plunger HSEC units**
 3,800 bar
 Used on all Classic units with a 30 or 50 horsepower rating
Replaces Part #20434777

- 0.88 plunger HSEC units**
 3,500 bar
 Used on all Classic version I units with a 50 horsepower rating
Replaces Part #20414862

PART No.

05059712

72119529

72120023

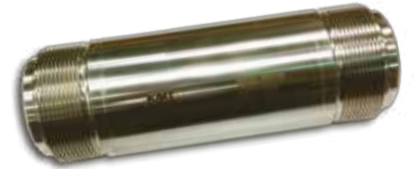

HIGH PRESSURE CYLINDER NUTS

- HP Cylinder Nut - HSEC (Hard Seal End Cap), 0.88 plunger**
 4,100 bar
 Used on all SL-V and OEM units with a 15 to 60 horsepower rating

- HP Cylinder Nut - SSEC (Soft Seal End Cap)**
 3,800 bar
 Used on all SL-IV units

80073646

05059688

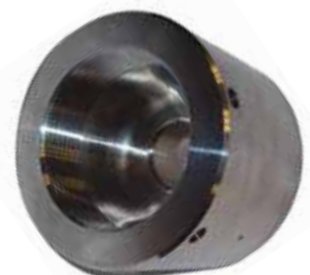

* Available on request

BUSHING RETAINER FLANGES

DESCRIPTION

PART No.

■ **0.88 plunger units**
 3,800/4,100 bar
 Used on all SL-IV, SL-V, Classic & OEM units
 with a 15 to 60 horsepower rating

05007786



■ **1.13 plunger units**
 4,100 bar
 Used on all SL-V units with a 75 to
 200 Horsepower rating

05145099



RETAINING RINGS

■ **1.011 x 0.030 x 0.118, Stainless Steel**
 6,200 bar
 Used on all 6,200 bar units

20492123



■ **2.75, Stainless steel**
 4,100 bar
 Used on all 4,100 bar units

05034798



MISCELLANEOUS

■ **Jackbolt - HSEC, 7/16-20 x 2.31**
 Used on all SL-V, Classic and OEM HSEC units

80070352



■ **HP Attenuator Assembly - 0.96L**
 Used on all 4,100 bar units

20498314







Sealing Heads

KMT's patent-pending sealing head design offers reliable, repeatable use. The metal-on-metal seal ensures that your KMT intensifier reaches operating pressure safely, providing hundreds of hours of operation to support your cutting needs.

The use of KMT Genuine Parts to rebuild your sealing head results in maximum value and safe operation.

DESCRIPTION

PART No.

- **0.88 plunger**
 6,200 bar.
 Used on all PRO-III units
- **0.88 plunger**
 6,200 bar.
 Used on all PRO-2 and SL-VI PRO units
- **0.88 plunger, 4 stud.**
 6,200 bar
 Used on all PRO-I units

 Uses o-ring 10146082 (p. 77)
- **1.13 plunger units HSEC-C**
 4,100 bar
 Used on all SL-VI units with a 100 to 200 horsepower rating
- **1.13 plunger units HSEC**
 4,100 bar
 Used on all SL-V units with a 75 to 200 horsepower rating
- **0.88 plunger units HSEC-C**
 3,800/4,100 bar
 Used on all SL-VI units with a 15 to 50 horsepower rating
- **0.88 plunger units HSEC**
 3,800/4,100 bar
 Used on all SL-V, Classic and OEM units with a 15 to 60 horsepower rating

72170157



20480087



20480113



72154603



72110979



72142526



20481005



* Available on request

SEALING HEAD ASSEMBLIES

DESCRIPTION

■ **0.88 plunger units**
4,100 bar
Used on SL-IV Plus flange units

■ **0.88 plunger units**
3,800 bar
Used on SL-IV units

Uses o-ring 05049853 (p. 77)

■ **0.88 plunger units**
3,800 bar
Used on NL-I units

PART No.

05144688



05116769



20417081



DESCRIPTION

PART No.

- **0.88 plunger units**
 6,200 bar
 Used on all sealing head assemblies for PRO-2 units
- **0.88 plunger units**
 6,200 bar
 Used on all sealing head assemblies for PRO-I units
- **1.13 plunger units**
 4,100 bar
 Used on all sealing head assemblies for SL-V units with a 75 to 200 horsepower rating
- **0.88 plunger units**
 3,800/4,100 bar
 Used on all sealing head assemblies for SL-V, Classic and OEM units with a 15 to 60 horsepower rating
- **0.88 plunger units**
 4,100 bar
 Used on SL-IV Plus flange units
- **1.13 plunger units**
 3,800 bar
 Used on SL-IV units with a 15 to 60 horsepower rating
- **0.88 plunger units**
 3,800 bar
 Used on NL-I units

72113373



20479524



72110961



20481009



05144357



10106417

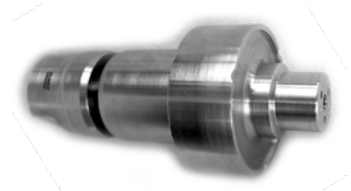

20417000



* Available on request

SEAL ASSEMBLIES

DESCRIPTION

PART No.

HP Sealing Head
3,800 bar.
Used on SL-IV units

10110393



GLANDS

UHP Sealing Head, 0.88 plunger units
6,200 bar
Used on all sealing head assemblies for PRO units

20481660



HP Sealing Head, 1.13 plunger units
4,100 bar
Used on all sealing head assemblies for SL-V units with a 75 to 200 horsepower rating

05116595



HP Sealing Head, 0.88 plunger units
3,800/4,100 bar
Used on all sealing head assemblies for SL-IV, SL-V, Classic & OEM units with a 15 to 60 horsepower rating

05116777



SPACERS

HP Sealing Head, 1.13 plunger units
4,100 bar
Used on all SL-V units with a 75 to 200 horsepower rating

05144597



HP Sealing Head
4,100 bar
Used on SL-IV Plus units with a 15, 30, 50 or 60 horsepower rating

05144696



DESCRIPTION

PART No.

UHP Check Valve PRO (Inlet/Discharge) Ball Style Inlet/discharge, 0.88 plunger units

72117819

6,200 bar
Used on all PRO-2 and PRO-III units that utilize an inlet ball. Kit includes seat, discharge poppet, inlet ball, poppet pin, dowel pin & compression spring



UHP Check Valve PRO-2 (Discharge) Discharge Kit, 0.88 plunger units

72135447

6,200 bar
Used on sealing head assemblies for PRO-2 units. Kit includes seat, discharge poppet, poppet pin & compression spring



UHP Check Valve (Poppet Style) Inlet Inlet/discharge, 0.88 plunger units

20477505

6,200 bar
Used on all sealing head assemblies for PRO-I units that utilize an inlet poppet. Kit includes valve seat, inlet and discharge poppets, poppet pin and compression spring



HP Check Valve, Discharge, 1.13 plunger units

80084403*

4,100 bar
Used on all sealing head assemblies for SL-V units with a 75 to 200 horsepower rating. Kit includes valve seat, discharge poppet, poppet pin and compression spring



* Available on request

DESCRIPTION

PART No.

■ **HP Check Valve Discharge, 0.88 plunger units**
 3,800/4,100 bar
 Used on all SL-V, Classic and OEM units with a 15 to 60 horsepower rating. Kit includes valve seat, discharge poppet, poppet pin and compression spring

05133335



■ **HP Check Valve, Inlet/Discharge, 1.13 plunger units**
 4,100 bar
 Used on all SL-V and SL-VI units with a *button style* poppet with a 75 to 200 horsepower rating. Kit includes valve seat, inlet and discharge poppets, poppet pin and compression spring

72125203



■ **HP Check Valve, Inlet/Discharge, 1.13 plunger units**
 4,100 bar
 Used on all SL-V units with *washer style* inlet with a 75 to 200 horsepower rating. Kit includes valve seat, inlet and discharge poppets, poppet pin and compression spring

20427747*



■ **HP Check Valve, Inlet/Discharge, 0.88 plunger units**
 3,800/4,100 bar
 Used on all SL-V and SL-VI units with a *button style* poppet with a 15 to 60 horsepower rating. Kit includes valve seat, inlet and discharge poppets, poppet pin, compression spring & poppet retainer screw

20489495



■ **HP Check Valve, Inlet/Discharge**
 3,800/4,100 bar
 Used on SL-IV & SL-V units with a *washer style* inlet poppet. Kit includes valve seat, inlet & discharge poppets, poppet pin & compression springs

80074057





* Available on request

Sealing Heads

order.spares@kmt-waterjet.com

Issue Fall 2016

26



Cutting Heads

Precise alignment of cutting head components is what ensures maximum component life and greatest productivity. KMT cutting heads are precision manufactured and precision aligned in our laboratory using proprietary alignment techniques to ensure the very best cutting performance. KMT delivers the best value for your cutting needs on any waterjet system.

KMT Cutting Heads are:

- **The result of over 40 years of cutting experience - longer than any other manufacturer**
- **Rated best in the industry by independent university testing**
- **The best solution for your cutting needs - available in multiple orifice sizes**

For maximum performance and value on any KMT pump and those manufactured by other OEMs, install a KMT cutting head.

For complete Cutting Heads, contact your local KMT representative (see page 91 for details)

ACTIVE AUTOLINE PRO



ACTIVE IDE PRO



CUTTING HEADS

DESCRIPTION

PART No.

IDE PRO Assembly

6,200 bar

Diamond Orifice

0.007" / 0.17 mm

20481407*

0.008" / 0.20 mm

20481408

0.009" / 0.23 mm

20481409

0.010" / 0.25 mm

20481410

0.011" / 0.28 mm

20481411

0.012" / 0.30 mm

20481412*

0.013" / 0.33 mm

20481413

0.014" / 0.35 mm

20481414

0.015" / 0.38 mm

20481415

0.016" / 0.40 mm

20481416

0.018" / 0.46 mm

20481418*



AUTOLINE PRO Assembly

6,200 bar, 0.75 UHP
(Orifice Assembly & Focusing Tube Not Included)

20480707



IDE II Assembly

4,100 bar

Diamond Orifice

0.007" / 0.17 mm

20477959007

0.008" / 0.20 mm

20477959008

0.009" / 0.23 mm

20477959009

0.010" / 0.25 mm

20477959010

0.011" / 0.28 mm

20477959011

0.012" / 0.30 mm

20477959012

0.013" / 0.33 mm

20477959013

0.014" / 0.35 mm

20477959014

0.016" / 0.40 mm

20477959016

0.018" / 0.46 mm

20477959018



DESCRIPTION

PART No.

IDE II Assembly

4,100 bar

Diamond Orifice & Short Stop Filter

0.007" / 0.17 mm

20477950007

0.008" / 0.20 mm

20477950008

0.009" / 0.23 mm

20477950009

0.010" / 0.25 mm

20477950010

0.011" / 0.28 mm

20477950011

0.012" / 0.30 mm

20477950012

0.013" / 0.33 mm

20477950013

0.014" / 0.35 mm

20477950014

0.016" / 0.40 mm

20477950016

0.018" / 0.46 mm

20477950018

AUTOLINE II Assembly

4,100 bar

0.030 wear insert, 0.38 HP

(Orifice Assembly & Focusing Tube Not Included)

20453949

0.043 wear insert, 0.38 HP

(Orifice Assembly & Focusing Tube Not Included)

20454108

AUTOLINE I Assembly

4,100 bar

0.030 wear insert, 0.38 HP

(Diamond & Focusing Tube Not Included)

05078530



* Available on request

Cutting Head Replacement Parts



KMT's AUTOLINE & IDE cutting heads include patented designs, engineered and manufactured to deliver the best cutting performance in the industry. Ensure you cut with the greatest value & speed by using KMT Genuine Parts.

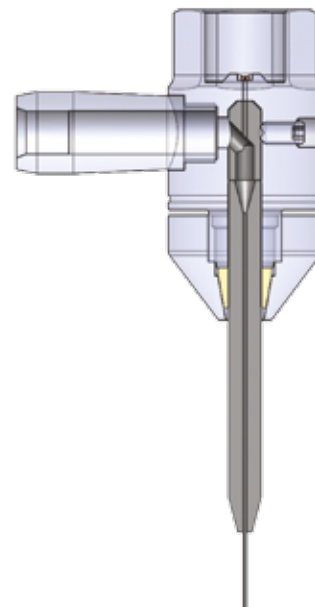

AUTOLINE CUTTING HEAD ASSEMBLY COMPONENTS

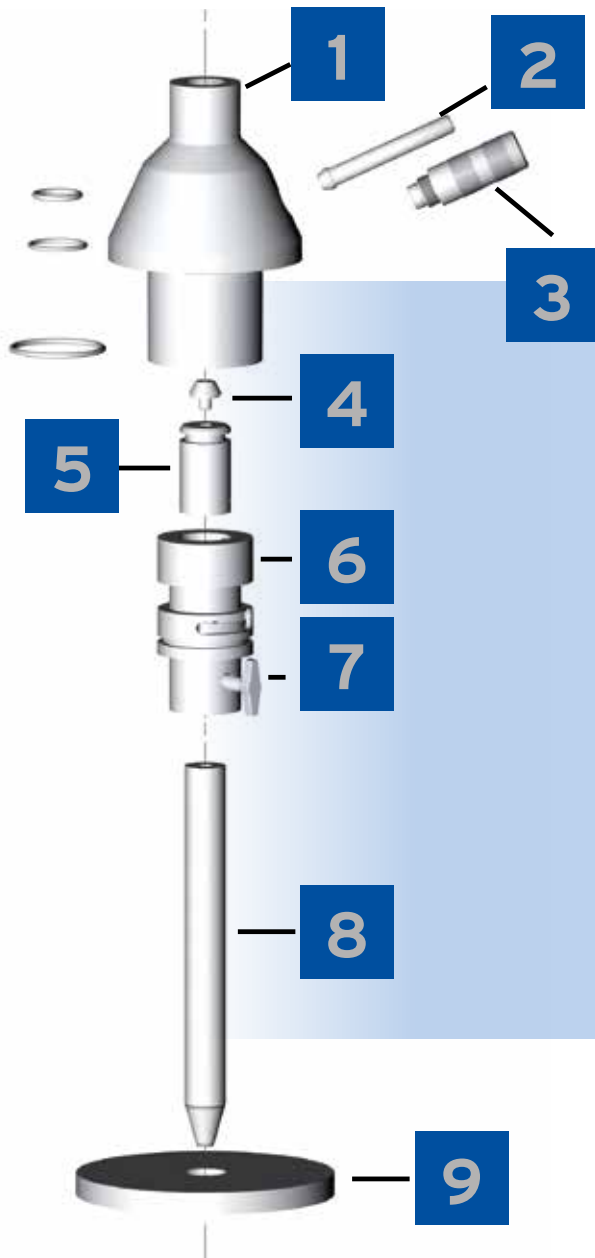

AUTOLINE II - Components

- 1 Cap
- 2 Abrasive Feed Liner
- 3 Handle
- 4 Diamond Orifice
- 5 LONGLIFE Mixing Chamber
- 6 Nozzle Body
- 7 Wing Screw Focusing Tube
- 8 LONGLIFE Focusing Tube
- 9 Guard

DESCRIPTION

PART No.

AUTOLINE PRO

6,200 bar
0.75 UHP

For o-rings see page 73

20480732



AUTOLINE II

4,100 bar
0.38 UHP

For o-rings see page 73

20453952



AUTOLINE I

4,100 bar
0.38 UHP

For o-rings see page 73

05076971



BODY

AUTOLINE PRO

6,200 bar
For o-rings see page 73

20480715



AUTOLINE II

4,100 bar
For o-rings see page 73

20453958



AUTOLINE I

4,100 bar
For o-rings see page 73

05073820



WEAR INSERTS

DESCRIPTION

PART No.

AUTOLINE PRO 6,200 bar	20458242*
AUTOLINE II 4,100 bar 0.030, 25° Inlet (for o-rings see page 73)	20453064
0.043, 25° Inlet	20453082*
0.054, 25° Inlet	20454339*
AUTOLINE I 4,100 bar 0.030, 45° Inlet, Tungsten Carbide	05076955
0.043, 45° Inlet, Tungsten Carbide	05135827*
0.052, 45° Inlet, Tungsten Carbide	20442434*



SPARE PARTS KITS

AUTOLINE PRO 6,200 bar Kit includes the setscrew and o-rings to service any AUTOLINE PRO assembly	20479589
AUTOLINE II 4,100 bar Kit includes the setscrew and o-rings to service any AUTOLINE II assembly	20454129
AUTOLINE I 4,100 bar Kit includes the setscrew and o-rings to service any AUTOLINE I assembly	05077367



* Available on request

ABRASIVE FEED TUBE ADAPTERS

DESCRIPTION

PART No.

 **AUTOLINE PRO & AUTOLINE II**
Stainless Steel

20453973



 **AUTOLINE I**
Stainless Steel

05076989



ABRASIVE FEED TUBE ASSEMBLY

 **AUTOLINE PRO & AUTOLINE II**

20453964



KNOB RETAINER

 **AUTOLINE PRO & AUTOLINE II**
Stainless Steel, T-Handle

20453976



 **AUTOLINE I**
Stainless Steel

05078712



ABRASIVE GUARD

 **AUTOLINE PRO, AUTOLINE II & I**

05087168



IDE RETAINING NUT

0.25 = 1/4 inch 0.56 = 9/16 inch
0.38 = 3/8 inch 0.75 = 3/4 inch

DESCRIPTION

PART No.



0.38, Stainless Steel

Used with IDE PRO and IDE II cutting heads

20454342

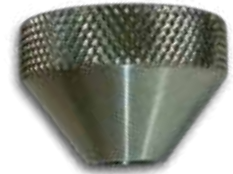

FOCUSING TUBE RETAINING COLLET



0.373 ID, Brass

Retaining ring for IDE PRO and IDE II cutting heads

20454345



SHORT STOP ADAPTER ASSEMBLY

4,100 bar. Required when incorporating an IDE II cutting head into an existing system with a KMT pneumatic valve



0.38 M x 0.25 F, High Pressure Tubing

20454363



0.38 M x 0.38 F, High Pressure Tubing

20454366



Short Stop Filter

20454426



* Available on request



Orifices & Focusing Tubes

KMT's proprietary diamond orifice mounting & alignment processes deliver a truly superior cutting stream, resulting in longer focus tube life and faster cutting. All of our diamond abrasive cutting orifices are tested in-house to assure the KMT quality you expect.

For water-only cutting try the KMT FOODgrade™ diamond orifice with a longer coherent cutting stream, exclusively from KMT. Call for details.

KMT offers focusing tubes in a variety of materials, prices and sizes to match your cutting needs from leading manufacturers Kennametal and Ceratizit.

ORIFICES FOR PURE WATER CUTTING

DESCRIPTION

PART No.

AQUALINE PRO

6,200 bar

Diamond Orifice

0.004" / 0.10 mm	20481704
0.005" / 0.12 mm	20481705
0.006" / 0.15 mm	20481706
0.007" / 0.17 mm	20481707
0.008" / 0.20 mm	20481708
0.009" / 0.23 mm	20481709
0.010" / 0.25 mm	20481710
0.011" / 0.28 mm	20481711*
0.012" / 0.30 mm	20481712
0.013" / 0.33 mm	20481713*
0.014" / 0.35 mm	20481714
0.015" / 0.38 mm	20481715*
0.016" / 0.40 mm	20481716
0.017" / 0.43 mm	20481717*
0.018" / 0.46 mm	20481718*
0.019" / 0.48 mm	20481719*
0.020" / 0.51 mm	20481720*
0.021" / 0.53 mm	20481721*
0.022" / 0.56 mm	20481722*



* Available on request

ORIFICES FOR PURE WATER CUTTING

DESCRIPTION

PART No.



4,100 bar

Diamond Orifice

0.003" / 0.07 mm

49888852

0.004" / 0.10 mm

49888860

0.005" / 0.12 mm

49888878

0.006" / 0.15 mm

49888886

0.007" / 0.17 mm

49888894

0.008" / 0.20 mm

49888902

0.009" / 0.23 mm

49888910

0.010" / 0.25 mm

49888928

0.012" / 0.30 mm

49888936

0.013" / 0.33 mm

49836786*

0.014" / 0.35 mm

49888944

0.015" / 0.38 mm

49888951

0.016" / 0.40 mm

49888969

0.018" / 0.46 mm

49888977

0.019" / 0.48 mm

20436198*

0.020" / 0.51 mm

49888985

0.022" / 0.56 mm

49888993

Sapphire Orifice

0.003" / 0.07 mm

A2260003*

0.004" / 0.10 mm

49863574

0.005" / 0.12 mm

49863582

0.006" / 0.15 mm

91954073

0.007" / 0.17 mm

49863590

0.008" / 0.20 mm

49865850

0.009" / 0.23 mm

49863608

0.010" / 0.25 mm

49863616

0.011" / 0.28 mm

A2260011*

0.012" / 0.30 mm

49863624

0.013" / 0.33 mm

A2260013*

0.014" / 0.35 mm

49863632

0.015" / 0.38 mm

A2260015

0.016" / 0.40 mm

A2260016

0.018" / 0.46 mm

A2260018*

0.019" / 0.48 mm

A2260019*

0.020" / 0.51 mm

A2260020*

0.022" / 0.56 mm

A2260022*



FOODGRADE™ ORIFICES FOR PURE WATER CUTTING

DESCRIPTION

PART No.

■ 4,100 bar
Diamond Orifice
0.005" / 0.12 mm
0.006" / 0.15 mm
0.007" / 0.17 mm
0.008" / 0.20 mm
0.009" / 0.23 mm
0.010" / 0.25 mm
0.011" / 0.28 mm

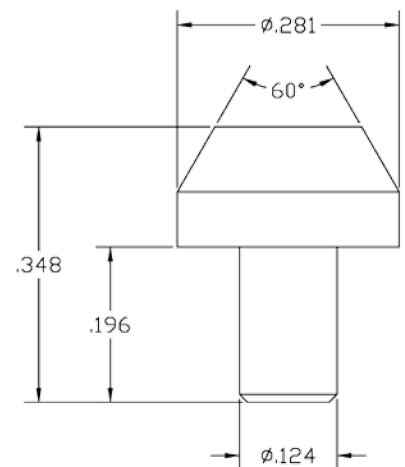
72113688
72132350
72113680
72132358
72136231
72136249
72136256



WATER ONLY ORIFICE COMPARISONS

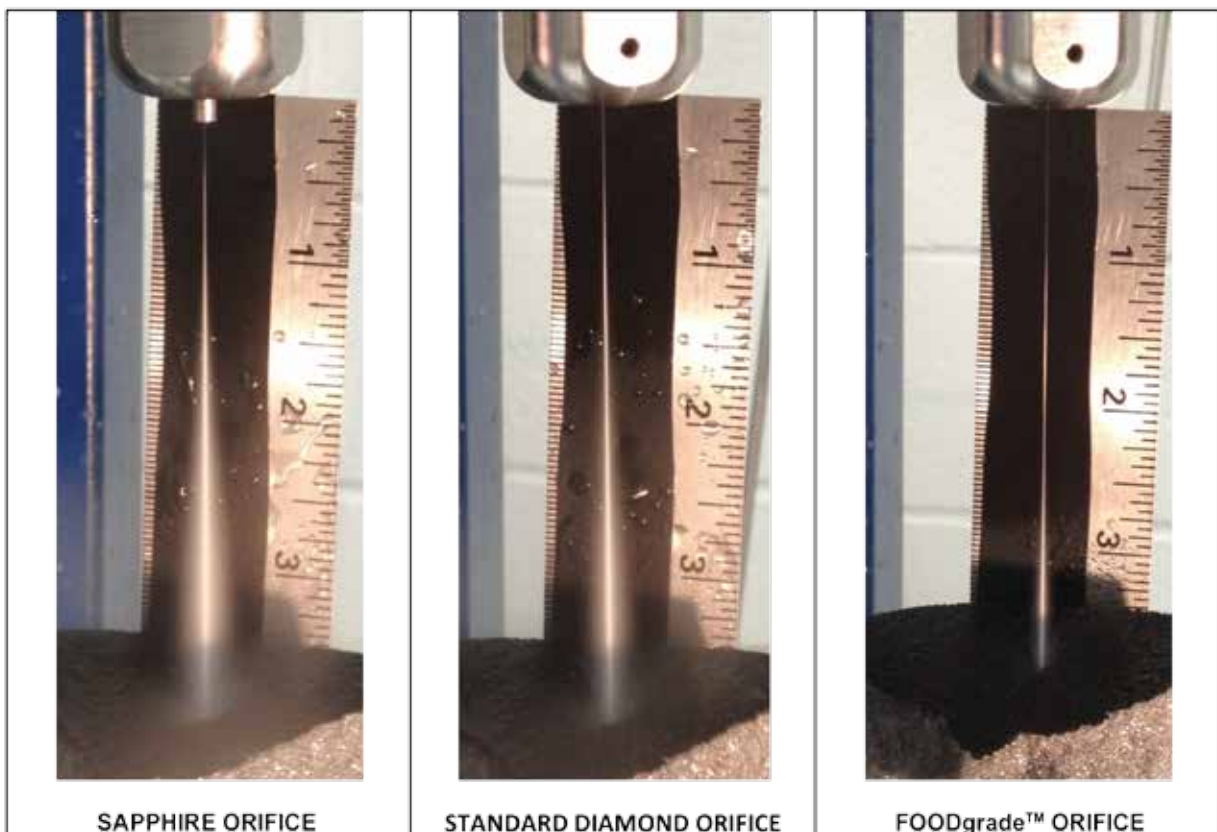

SAPPHIRE ORIFICE

STANDARD DIAMOND ORIFICE

FOODgrade™ ORIFICE

* Available on request

ORIFICES FOR ABRASIVE CUTTING

DESCRIPTION

PART No.

AUTOLINE PRO

6,200 bar
For True Alignment & Maximum Performance

Wear Insert Cartridge with Diamond Orifice

0.007" / 0.17 mm	20481607
0.008" / 0.20 mm	20496208
0.009" / 0.23 mm	20481609
0.010" / 0.25 mm	20496210
0.011" / 0.28 mm	20496211
0.012" / 0.30 mm	20496212
0.013" / 0.33 mm	20481613
0.014" / 0.35 mm	20496214
0.015" / 0.38 mm	20496215



ORIFICES FOR ABRASIVE CUTTING

DESCRIPTION

PART No.

AUTOLINE I & II
4,100 bar
For True Alignment & Maximum Performance

Diamond Orifice

0.004" / 0.10 mm	20448625*
0.007" / 0.17 mm	05063847
0.008" / 0.20 mm	05112537
0.009" / 0.23 mm	05084504
0.010" / 0.25 mm	05077029
0.011" / 0.28 mm	05101753
0.012" / 0.30 mm	05077300
0.013" / 0.33 mm	05136098
0.014" / 0.35 mm	05077037
0.015" / 0.38 mm	80075781*
0.016" / 0.40 mm	05121512
0.018" / 0.46 mm	05114905*
0.019" / 0.48 mm	80086663*
0.020" / 0.51 mm	05114897

Sapphire Orifice

0.004" / 0.10 mm	05214794
0.005" / 0.12 mm	05222836
0.007" / 0.17 mm	80217
0.008" / 0.20 mm	80220
0.009" / 0.23 mm	80423
0.010" / 0.25 mm	80225
0.011" / 0.28 mm	80227
0.012" / 0.30 mm	80230
0.013" / 0.33 mm	80433
0.014" / 0.35 mm	80235
0.016" / 0.40 mm	80240
0.018" / 0.46 mm	80245
0.019" / 0.48 mm	80086671*
0.020" / 0.51 mm	05114921



* Available on request

FOCUSING TUBES

DESCRIPTION

PRO Series Indexed

The PRO Series features the superior HYPER-TUBE Index Design for longer, more uniform wear preventing "focusing tube blow-out"

0.030 x 3.0 / 0.76 mm x 76 mm

20477366

0.030 x 4.0 / 0.76 mm x 102 mm

20477382

0.033 x 4.0 / 0.84 mm x 102 mm

20490760

0.040 x 3.0 / 1.02 mm x 76 mm

20486133*

0.040 x 4.0 / 1.02 mm x 102 mm

20486166*

0.043 x 3.0 / 1.10 mm x 76 mm

20477386

0.043 x 4.0 / 1.10 mm x 102 mm

20477395

0.045 x 3.0 / 1.14 mm x 76 mm

20486151*

0.045 x 4.0 / 1.14 mm x 102 mm

20486158

0.048 x 4.0 / 1.22 mm x 102 mm

20490768

ROCTEC® 100

0.021 x 3.13 / 0.53 mm x 79 mm

20451227*

0.025 x 3.13 / 0.63 mm x 79 mm

20452309*

0.030 x 3.13 / 0.76 mm x 79 mm

10126969

0.036 x 3.13 / 0.91 mm x 79 mm

80075252

0.039 x 3.13 / 0.99 mm x 79 mm

49833593*

0.040 x 3.13 / 1.02 mm x 79 mm

49835390

0.043 x 3.13 / 1.10 mm x 79 mm

10126928

0.052 x 3.13 / 1.32 mm x 79 mm

05117528

0.058 x 3.13 / 1.47 mm x 79 mm

05051891*

0.063 x 3.13 / 1.60 mm x 79 mm

10126936

ROCTEC® 500

0.021 x 2.0 / 0.53 mm x 50 mm

05097928

0.030 x 3.13 / 0.76 mm x 79 mm

05097944

0.036 x 3.13 / 0.91 mm x 79 mm

05116652

0.043 x 3.13 / 1.10 mm x 79 mm

05097936

0.093 x 3.13 / 2.36 mm x 79 mm

05130927*

HyperTube®
Index Design





* Available on request

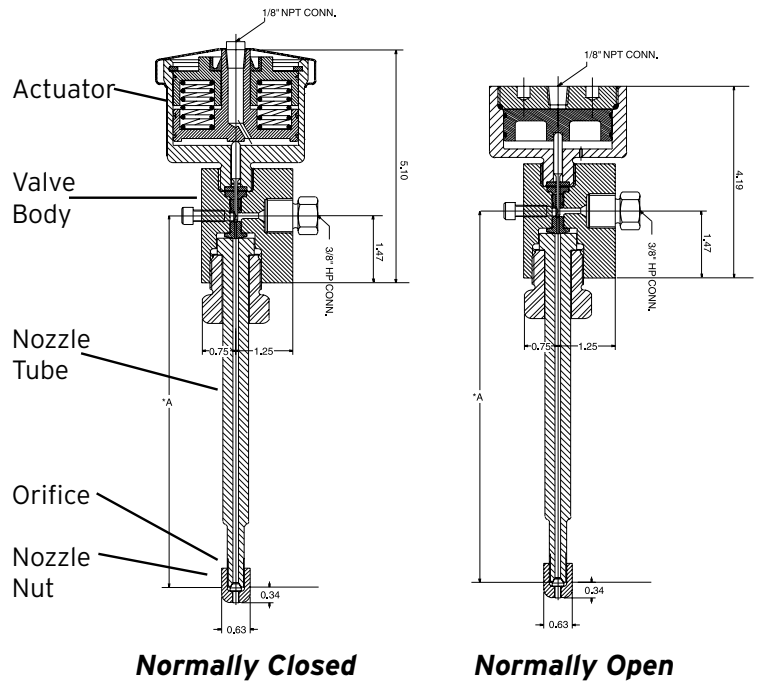

Pneumatic Valves & Replacement Parts

When you need reliability, speed and safety you turn to KMT. The newly designed Aqualine pneumatic valves from KMT Waterjet use an innovative seal and stem design to maximize life and deliver the greatest value. These valves enable longer production runs, resulting in increased output.

Designed to Perform Longer

The Aqualine Normally Open & Normally Closed (NO/NC) valves have very reliable and fast performance due to the 6 stainless

steel springs which apply the force to open or close the valve. The re-designed valves have an improved stem design and specialized seals which provide a far better performance and enable increased production.

The dump valve safely relieves pressure during any waterjet operation. Using KMT Genuine Parts ensures that your dump valve operates reliably as designed.

PNEUMATIC VALVE / ACTUATOR ASSEMBLIES

DESCRIPTION

PART No.

- **UHP, 6,200 bar - N/C**

- **UHP, 6,200 bar - N/O**
 2-port Dump valve

- **HP, 4,100 bar - N/C**

- **HP, 4,100 bar - N/C, IDE® Gland**

- **HP, 4,100 bar - N/O**

- **HP, 4,100 bar - N/O**
 2-Port Dump valve, Solenoid valve,
 Square body

- **HP, 4,100 bar - N/O**
 3-Port Dump valve, Round body

20480359

20468634

10138824

20454354

10184760

05069703

20427739



* Available on request

DESCRIPTION

PART No.

■ UHP Pneumatic Valve, N/C, 6,200 bar

Kit includes valve seat and stem, seal assembly, brass backup ring and o-rings required to service the valve and the actuator

20477521



■ UHP Pneumatic Valve, N/O, 6,200 bar

Kit includes valve seat and stem, seal assembly, brass backup ring and o-rings required to service the valve and the actuator

20477518

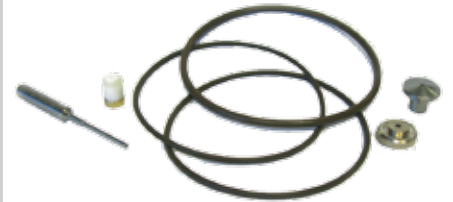

■ HP Pneumatic Valve, N/C, 4,100 bar

Kit includes valve seat and stem, seal assembly, backup ring & o-ring required to service the valve

05116025



■ HP Pneumatic Valve, N/C, Cold Weather Seal Assembly, 4,100 bar

Kit includes valve stem and seat, CWS seal assembly, bronze backup ring and o-ring

05146964*



■ HP Pneumatic Valve, N/O, 4,100 bar

Kit includes valve seat and stem, seal assembly, backup ring & o-rings required to service the valve and the actuator

05116017



DESCRIPTION

PART No.



N/C Actuator Assembly

4,100/6,200 bar
Kit includes top and bottom protector tool, and snap ring pliers to service all HP and UHP, N/C pneumatic actuator assemblies

80077795



Seal Tools, HP/UHP Pneumatic Valves

4,100/6,200 bar
Used to service all HP and UHP pneumatic valves. Kit includes a seal push, positioning and installation tool

20470475



PNEUMATIC VALVE BODIES



Stainless Steel

6,200 bar.
For use on all KMT UHP pneumatic valves

20475871



Dump Valve, Stainless Steel

6,200 bar.
For use on all KMT UHP pneumatic dump valves

20468617



2-Port, (2) 0.38, (1) 0.56, Stainless Steel

4,100 bar.
For use on all KMT 2-port HP pneumatic valves

10189181



3-Port, 0.38, Stainless Steel

4,100 bar.
For use on all KMT 3-port HP pneumatic dump valves

20427648



* Available on request

DESCRIPTION

PART No.

■	<p>UHP Actuator - N/C 6,200 bar For o-rings see page 71</p>
■	<p>UHP Actuator - N/O 6,200 bar For o-rings see page 71</p>
■	<p>HP Actuator - N/C 4,100 bar For o-rings see page 71</p>
■	<p>HP Actuator - N/O 4,100 bar For o-rings see page 71</p>
■	<p>Solenoid Valve - 24V DC 5,4 W 8,5 W, for AQUALINE Cutting Head</p>

20474154

20479022

10177855

10189553

49888035

05450127



DESCRIPTION

PART No.

UHP Pneumatic Valve, Stainless Steel
6,200 bar
For use on all KMT UHP pneumatic valves

20475882



HP Pneumatic Valve, Stainless Steel
4,100 bar
For use on all KMT HP pneumatic valves

10187250



NOZZLE NUTS

0.56, UHP
6,200 bar

20478993

KMT
Photo not available

0.75, UHP
6,200 bar

20480993

0.38, LH Thread
4,100 bar

49863665

0.56, LH Thread
4,100 bar

49865405



TORQUE WRENCH FOR NOZZLE NUTS

Torque Wrench

05225470

Insertion 0.38

05225488

Insertion 0.56

05225496



DESCRIPTION

PART No.



**0.56, Valve nut for Nozzle Tube,
Stainless Steel**

49894249

6,200/4,100 bar



**0.75, Valve nut for Nozzle Tube,
Stainless Steel**

20454351

6,200/4,100 bar



**Compression Spring - 0.72 x 0.105 x 1.50,
Stainless Steel**

05054119

For use on all NC KMT HP/UHP pneumatic actuators



Adapter, HP Water Valve

49830904

4,100 bar
For use on all HP 3-port and quick release dump valves



Adapter, Tube/Pipe, 0.25 x 0.13

10077030

Used to connect air tube to solenoid valve on pneumatic valve/actuator assemblies



Coupling Pipe, 0.13 x 0.13

10102226

Used to connect solenoid valve to actuator on pneumatic valve/actuator assemblies



DESCRIPTION

(ALL DIMENSIONS ARE DIAMETER" x LENGTH")

PART No.

3/4" Ultra High Pressure Nozzle Tube, for use with Short Stop Filter, 6,200 bar

0.75 x 3.50 / 1.9 x 8.89 cm, LH Thread	20487241
0.75 x 4.50 / 1.9 x 11.43 cm, LH Thread	20487249
0.75 x 5.75 / 1.9 x 14.60 cm, LH Thread	20487257
0.75 x 6.25 / 1.9 x 15.88 cm, LH Thread	20497106*
0.75 x 9.75 / 1.9 x 24.77 cm, LH Thread	20487273



* Available on request

NOZZLE TUBES

DESCRIPTION

(ALL DIMENSIONS ARE DIAMETER" x LENGTH")

PART No.

3/8" Connection, 4,100 bar	
0.38 x 4.0 / 0.97 x 10.16 cm	10138584
0.38 x 5.0 / 0.97 x 12.70 cm	10138592
0.38 x 6.0 / 0.97 x 15.24 cm	10138600
0.38 x 7.0 / 0.97 x 17.78 cm	10138618
0.38 x 8.0 / 0.97 x 20.32 cm	10138634
0.38 x 9.0 / 0.97 x 22.86 cm	10138642
0.38 x 10.0 / 0.97 x 25.40 cm	10138659
3/8" Nozzle Nut Connection, 4,100 bar	
0.38 x 3.0 / 0.97 x 10.16 cm	10181113
0.38 x 4.0 / 0.97 x 10.16 cm	10138402
0.38 x 5.0 / 0.97 x 12.70 cm	10138410
0.38 x 6.0 / 0.97 x 15.24 cm	10138428
0.38 x 7.0 / 0.97 x 17.78 cm	10138436
0.38 x 8.0 / 0.97 x 20.32 cm	10138444
0.38 x 9.0 / 0.97 x 22.86 cm	10138451
0.38 x 10.0 / 0.97 x 25.40 cm	10138469
0.38 x 11.0 / 0.97 x 27.94 cm	05136031*
0.38 x 12.0 / 0.97 x 30.48 cm	05013735
3/8" Nozzle Nut Connection W/High Pressure Connection, 4,100 bar	
0.38 x 3.0 / 0.97 x 7.62 cm	A22593*
0.38 x 4.0 / 0.97 x 10.16 cm	A22594*
0.38 x 5.0 / 0.97 x 12.70 cm	A22595*
0.38 x 6.0 / 0.97 x 15.24 cm	A22596*
0.38 x 8.0 / 0.97 x 20.32 cm	A2259800*
0.38 x 10.0 / 0.97 x 25.40 cm	A225910*
0.38 x 11.0 / 0.97 x 27.94 cm	A225911*
0.38 x 12.0 / 0.97 x 30.48 cm	A225912*



DESCRIPTION

(ALL DIMENSIONS ARE DIAMETER" x LENGTH")

PART No.

<p>9/16" Connection, 4,100 bar</p>	0.56 x 4.0 / 1.42 x 10.16 cm	10138667
	0.56 x 5.0 / 1.42 x 12.70 cm	10138675
	0.56 x 6.0 / 1.42 x 15.24 cm	10138683
	0.56 x 7.0 / 1.42 x 17.78 cm	10138691
	0.56 x 8.0 / 1.42 x 20.32 cm	10138709
	0.56 x 9.0 / 1.42 x 22.86 cm	10138717
	0.56 x 10.0 / 1.42 x 25.40 cm	10138725
	0.56 x 11.0 / 1.42 x 27.94 cm	80074446*
<p>9/16" Nozzle Nut Connection, 4,100 bar</p>	0.56 x 4.0 / 1.42 x 10.16 cm	10138485
	0.56 x 5.0 / 1.42 x 12.70 cm	10138493
	0.56 x 6.0 / 1.42 x 15.24 cm	10138501
	0.56 x 7.0 / 1.42 x 17.78 cm	10138519
	0.56 x 8.0 / 1.42 x 20.32 cm	10138527
	0.56 x 9.0 / 1.42 x 22.86 cm	10138535
	0.56 x 10.0 / 1.42 x 25.40 cm	10181105*
	0.56 x 12.0 / 1.42 x 30.48 cm	10193100*
<p>3/4" For use with KMT IDE Cutting Head, 4,100 bar</p>	0.75 x 3.75 / 1.91 x 9.53 cm, LH Thread	20489074
	0.75 x 4.75, / 1.91 x 12.07 cm, LH Thread	20489092
	0.75 x 5.75 / 1.91 x 14.60 cm, LH Thread	20455329
	0.75 x 7.75 / 1.91 x 19.69 cm, LH Thread	20480977
	0.75 x 8.75 / 1.91 x 22.23 cm, LH Thread	72101354*
	0.75 x 9.75 / 1.91 x 24.77 cm, LH Thread	20464647



* Available on request



High Pressure Fittings & Tubing

KMT offers high pressure tubing and fittings for all waterjet system needs and other high-pressure applications. Engineered for long life and reliability, KMT fittings are rated for use at 4,100 bar and 6,900 bar.

KMT employs proprietary manufacturing processes to ensure the longest life for HP and UHP tubing. Customized design is available to meet your needs - contact KMT Customer Service for details.

DESCRIPTION

PART No.

Stainless Steel Tubing

6,900 bar

Coned & Threaded - Up to 4' Lengths

0.25 x 0.083 x 3.02", HP160	20489761*
0.25 x 0.083 x 4.0", HP160	20487975*
0.25 x 0.083 x 7.625", HP160	72104402*
0.38 x 0.125 x 4.0", HP160	20478649
0.38 x 0.125 x 4.81", HP160	20468830
0.38 x 0.125 x 48.0", HP160	20489107*
0.56 x 0.188 x 4.25", HP160	20493999
0.56 x 0.188 x 6.38", HP160	72103733
0.56 x 0.188 x 8.93", HP160	72103386*
0.56 x 0.188 x 14.49", HP160	72103361*
0.56 x 0.188 x 17.22", HP160	72103379*
0.56 x 0.188 x 36.0", HP160	72108319*

Coned & Threaded - 20' Length

0.25 x 0.083 x 240.0", HP160	20478751
0.38 x 0.083 x 240.0", HP160	20489115*
0.56 x 0.083 x 240.0", HP160	72103535*

HP Tubes sold by meter

0.25	20455338
0.38	05210265
0.56	05210273



* Available on request

HIGH PRESSURE TUBING

DESCRIPTION

PART No.

Stainless Steel Tubing

4,500 bar

Coned & Threaded - Up to 8' Lengths

0.25 x 0.083 x 4.0", 316	10105880*
0.25 x 0.083 x 6.0", 316	10103018*
0.25 x 0.083 x 8.0", 316	80070519*
0.38 x 0.125 x 3.0", 316	10094704
0.38 x 0.125 x 4.0", 316	10105443
0.38 x 0.125 x 5.0", 316	10090280
0.56 x 0.188 x 4.0", 316	10069326
0.56 x 0.188 x 4.97", 316	05112057

Coned & Threaded - 20' Length

0.25 x 0.083 x 240.0", 316	10094191*
0.38 x 0.083 x 240.0", 316	10094183
0.56 x 0.083 x 240.0", 316	10094175*

HP Tubes sold by meter

0.25	91956078
0.38	91956094
0.56	91956102



DESCRIPTION

PART No.

Hose - Ferrule

0.25 x 0.265 x 0.718, Brass

20422970

0.38 x 0.265 x 0.718, Brass

10083897

0.56 x 0.265 x 0.718, Brass

05131347



Conduit - Extra Flexible

0.25, Stainless steel

20422988

0.38, Stainless steel

10186153

0.56, Stainless steel

05086905



 **HP & UHP stainless steel bent tubing is intensifier model specific. Please contact your local KMT representative (see page 91) for ordering assistance.**



 **HP & UHP stainless steel coils are robot specific. Please contact your local KMT representative (see page 91) for ordering assistance.**



HP hoses

Multilayer stainless steel mesh with ferrule terminals of 316 stainless steel (V4A). Interior lined with polyoxymethylene.

Multiple lengths available.

Please contact your local KMT representative (see page 91) for ordering assistance.



HIGH PRESSURE FITTINGS

DESCRIPTION

PART No.

UHP Stainless Steel Coupling Assembly, 6,900 bar

0.25 x 0.25

20477023

0.38 x 0.25

20477738

0.38 x 0.38

20477660

0.56 x 0.25

20477730

0.56 x 0.38

20477709

0.56 x 0.56

20477685

HP Stainless Steel Coupling Assembly, 4,100 bar

0.25 x 0.25

10079028

0.38 x 0.25

10079614

0.38 x 0.38

10078905

0.56 x 0.25

10078145

0.56 x 0.38

10079531

0.56 x 0.56

10078640

UHP Stainless Steel Elbow Assembly, 6,900 bar

0.25

20455821

0.38

20455809

0.56

20455377

HP Stainless Steel Elbow Assembly, 4,100 bar

0.25

10079051

0.38

10078780

0.56

10078525

DESCRIPTION

PART No.

**UHP Stainless Steel Tee Assembly,
6,900 bar**

0.25

20455824

0.38

20455812

0.56

20455374



**HP Stainless Steel Tee Assembly,
4,100 bar**

0.25

10079481

0.38

10078590

0.56

10079465



**UHP Stainless Steel Cross Assembly,
6,900 bar**

0.25

20452971

0.38

20452968

0.56

20453115



**HP Stainless Steel Cross Assembly,
4,100 bar**

0.25

10097228

0.38

10078038

0.56

10079168



* Available on request

HIGH PRESSURE FITTINGS

DESCRIPTION

PART No.

UHP Stainless Steel Bushing Assembly, 6,900 bar	0.38 F x 0.25 M	72133175
	0.38 M x 0.25 F	72133224
	0.56 F x 0.25 M	72133183
	0.56 M x 0.25 F	72133232
	0.56 F x 0.38 M	72133209
	0.56 M x 0.38 F	72133250
HP Stainless Steel Bushing Assembly, 4,100 bar	0.38 M x 0.25 F	10079432
	0.38 F x 0.25 M	10079473
	0.56 M x 0.25 F	10079580
	0.56 F x 0.25 M	10079424
	0.56 M x 0.38 F	10079457
	0.56 F x 0.38 M	10079655
	0.75 M x 0.56 F	49837206*
	0.75 F x 0.56 M	49832801*
UHP Stainless Steel Collar 6,900 bar	0.25	20452959
	0.38	20452965
	0.56	20453124
HP Stainless Steel Collar 4,100 bar	0.25	10078426
	0.38	10078715
	0.56	10079119

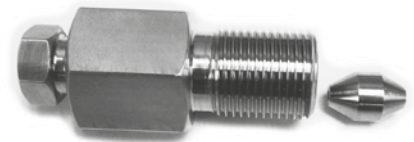

DESCRIPTION	PART No.
UHP Stainless Steel Gland 6,900 bar	
0.25	20452962
0.38	20452956
0.56	20453121
HP Stainless Steel Gland 4,100 bar	
0.25	10078459
Anti-Vibration, 0.25	10078699
0.38	10078129
Anti-Vibration, 0.38	10078913
0.56	10078608
Anti-Vibration, 0.56	10093573
0.75	49832678*
UHP Stainless Steel Adapter Cone, 6,900 bar	
0.25	72133266
0.38	72122072
0.56	72133349
HP Stainless Steel Adapter Cone, 4,100 bar	
0.25	10116333
0.38	10078509
0.56	10079291

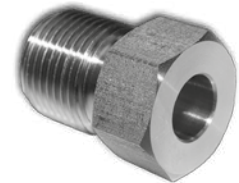
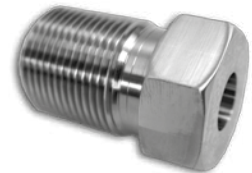

* Available on request

HIGH PRESSURE FITTINGS

DESCRIPTION

PART No.

UHP Stainless Steel Plug, 6,900 bar

0.25

20453130

0.38

20453136

0.56

20453127

HP Stainless Steel Plug, 4,100 bar

0.25

10078244

0.38

10079523

0.56

10078772

UHP Stainless Steel Hand Valve, Straight, 6,900 bar

0.25

20467981

0.38

20468568

0.56

20468014

HP Stainless Steel Hand Valve, Straight, 4,100 bar

0.25

10079259

0.38

10078863

0.56

10078889

DESCRIPTION

PART No.

- **UHP Stainless Steel Hand Valve, 90 degree, 6,900 bar**

0.25

20468610

0.38

20468593

0.56

20477836



- **HP Stainless Steel Hand Valve, 90 degree, 4,100 bar**

0.25

10079002

0.38

10078749

0.56

10079275



- **HP Stainless Steel Valve Assembly, 3-Way, 1 Press, 0.38, 2 Stem 4,100 bar**

10119030



- **Repair Kit for 1 Stem Hand Valves 4,100 bar**

05218652



* Available on request

DESCRIPTION

PART No.

**Poppet Check Valve PRO,
6,900 bar**

0.38

20477619

0.56

20455911



**Poppet Check Valve,
4,100 bar**

0.25

80073885

0.38

05075999

0.56

10096139



DESCRIPTION

PART No.

- **Filter Element
UHP Water Filter Assembly**

 6,200 bar
 Sintered Cup, 20 Micron.
 For use with UHP Filter Assembly 20475916
 & 20475944
- **Filter Element
UHP Water Filter Assembly**

 6,200 bar
 Sintered Cup, 20 Micron.
 For use with UHP Filter Assembly 20481026
 & 20480940
- **Filter Element - HP Water Filter Assembly**

 4,100 bar
 0.25, Sintered Cup, 20 Micron.
 For use with HP Filter Assembly 05114137
- **Filter Element - HP Water Filter Assembly**

 4,100 bar
 .38, Sintered Cup, 20 Micron.
 For use with HP Filter Assembly 49863715
- **Filter Element - HP Water Filter Assembly**

 4,100 bar
 0.56, Sintered Cup, 20 Micron.
 For use with HP Filter Assembly 49893555

20453553



20456913



05110531



49862261









49894272



* Available on request

HP WATER FILTER ASSEMBLIES

DESCRIPTION	PART No.	
UHP Water Filter Assembly - Inline		
6,200 bar Small		
0.25, Stainless Steel	20481026	
0.38, Stainless Steel	20480940	
UHP Water Filter Assembly - Inline		
6,200 bar Large		
0.38, Stainless Steel	20475916	
0.56, Stainless Steel	20475944	
HP Water Filter Assembly - Inline	05114137	
4,100 bar 0.25, 20 Micron, Stainless Steel		
HP Water Filter Assembly - Inline	49863715	
4,100 bar 0.38, 20 Micron, Stainless Steel		
HP Water Filter Assembly - Inline	49893555	
4,100 bar 0.56, 20 Micron, Stainless Steel		
Bayonet Nipple - HP Water Filter	05044375	
4,100 bar 0.38 For use in HP Filter Assembly 49863715		

All dimensions in inch unless specified otherwise.

DESCRIPTION

PART No.

- **UHP, 90°, 0.25 F/F Connections**
6,200 bar
- **HP, 90°, 0.25 F/F Connections**
4,100 bar
- **HP, 90°, 0.25 M/F Connections**
4,100 bar
- **HP, 90°, 0.38 M/F Connections**
4,100 bar

20491098

80129

91959130

10134682



SWIVEL JOINTS - CAP ASSEMBLIES

- **Cap Assembly, 0.25/0.38, M/F**
4,100 bar
- **Cap Assembly, 0.25, F/F**
4,100 bar

91959643

80125



SWIVEL JOINTS - STRAIGHT BODIES

- **UHP Body - Straight, 0.25 Connections**
6,200 bar
- **HP Body - Straight, 0.25 Connections**
4,100 bar
- **HP Body - Straight, 0.38 Connections**
4,100 bar

20486976

05024641

10134716*



* Available on request

SWIVEL JOINTS - SPINDLES

DESCRIPTION

■ UHP Spindle - 0.25 F
6,200 bar

■ UHP Spindle - 0.25 M
6,200 bar

■ HP Spindle - 0.25 F
4,100 bar

■ HP Spindle - 0.25 M
4,100 bar

■ HP Spindle - 0.38 M
4,100 bar

PART No.

20486952

20490843

80126

91959668

49899602



KMT
Photo not available



SWIVEL JOINTS - STRAIGHTS

■ UHP, Straight, 0.25 F/F Connections
6,200 bar

■ UHP, Straight, 0.25 F/M Connections
6,200 bar

■ HP, Straight, 0.25 F/F Connections
4,100 bar

■ HP, Straight, 0.25 M/F Connections
4,100 bar

■ HP, Straight, 0.38 M/F Connections
4,100 bar

20477623

20490851

80130

91959122

10134708

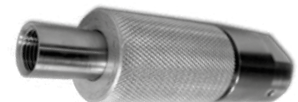

90 DEGREE BODIES

0.25 = 1/4 inch 0.56 = 9/16 inch
0.38 = 3/8 inch 0.75 = 3/4 inch

DESCRIPTION

PART No.

UHP Body - 90°, 0.25 Connections
6,200 bar

20490859

HP Body - 90°, 0.56 x 0.25 M/F Connections
4,100 bar

91959635

HP Body - 90° 0.38 x 0.38 M/F Connections
4,100 bar

10134690



BUSHINGS

Bushing, 0.25/0.38 Connection
4,100 bar

91959627



THRUST BEARINGS

Thrust Bearing, 0.25 Connections
6,200 bar

20475956

Thrust Bearing 0.25/0.38 Connection
4,100 bar

10084713



* Available on request

DESCRIPTION

PART No.

- Seal Assembly, 0.25 Connections**
 6,200 bar
- Seal Assembly, 0.25/0.38 Connection**
 4,100 bar
- Clamp Collar, 0.25, F/F Connection**
 4,100 bar
- Thrust Washer, 0.25/0.38 Connections**
 4,100 bar

20487002

91959650

10154680

10094647



DESCRIPTION

PART No.

Repair Kit -UHP Swivel Joint Assembly, 0.25/0.38 Connections

72129713*

6,200 bar

Kit includes seal assembly, thrust bearing and washer, and setscrew required to service all UHP swivel joint assemblies



Tool Kit - UHP Swivel Joint Assembly

20488720

6,200 bar

Kit includes maintenance tools and lubricants required to repair any UHP swivel joint assembly



Repair Kit - HP Swivel Joint Assembly, 0.25/0.38 Connections

05116009

4,100 bar

Kit includes seal assembly, thrust bearing and washer, and setscrew required to service all HP swivel joint assemblies



* Available on request

CONING & THREADING TOOL KITS

DESCRIPTION

PART No.

 **Tool Kit - Hand Coning/Threading Tools**
 Kit includes 0.25, 0.38 and 0.56 hand coning & hand threading tool

20454198*



 **Tool Kit - Power Coning/Threading Tools**
 Kit includes 0.25, 0.38 and 0.56 power coning & power threading tool

20454201



CONING TOOL ASSEMBLIES

TOOL ASSEMBLIES INCLUDE 4 OZ CONING LUBRICANT

 **Hand Coning Tool Assemblies**

0.25

05108832

0.38

05108857

0.56

05108840



 **Power Coning Tool Assemblies**

0.25

05109897

0.38

05109889

0.56

05109871



THREADING TOOL ASSEMBLIES

0.25 = 1/4 inch 0.56 = 9/16 inch
0.38 = 3/8 inch 0.75 = 3/4 inch

DESCRIPTION

PART No.

TOOL ASSEMBLIES INCLUDE 4 oz CONING LUBRICANT



Hand Threading Tool Assemblies

0.25	05108865
0.38	05108873
0.56	05108881



Power Threading Tool Assemblies

0.25	05122742
0.38	05120258
0.56	05122759



CONING & THREADING



Blade

0.25, Hand or Power, Coning	05108808
0.38, Hand or Power, Coning	05108824
0.56, Hand or Power, Coning	05108816



Retainer

0.25, Hand or Power, Bronze, Threading	05108741*
0.38, Hand or Power, Bronze, Threading	05108758
0.56, Hand or Power, Bronze, Threading	05108766



Retainer

0.25, Power, Bronze, Coning	05109814
0.38, Power, Bronze, Coning	05109822*
0.56, Power, Bronze, Coning	05109830*



Tube Vise

0.25	05108782
0.38	05108790
0.56	05108774



* Available on request

CONING & THREADING

DESCRIPTION

PART No.

Threading Die 1/4-28 LH, 0.25, Hand or Power 3/8-24 LH, 0.38, Hand or Power 9/16-18 LH, 0.56, Hand or Power	05108899
	05108915
	10078301
Collet 0.25, Hand Coning, Stainless Steel 0.38, Hand Coning, Stainless Steel 0.56, Hand Coning, Stainless Steel	05108972
	05108964*
	20439964*



HAND CONING & THREADING TOOL KIT "SMALL BLADE"

Tool Kit - Hand Coning/Threading Tools Kit includes 0.25, 0.38 and 0.56 hand coning & hand threading tool	05210174
---	-----------------



HAND CONING & THREADING TOOL ASSEMBLIES

Hand Coning Tool Assemblies 0.25 0.38 0.56	80386
	80387
	80141
Hand Threading Tool Assemblies 0.25 0.38 0.56	80388
	80389
	80145



All dimensions in inch unless specified otherwise.

Issue Fall 2016

DESCRIPTION	PART No.
Collet 0.25, Hand Coning 0.38, Hand Coning 0.56, Hand Coning	80142 80143 80144
Blade Hand Coning, 0.25 - 0.56	80152
Threading Die 1/4-28 LH, 0.25, Hand Threading 3/8-24 LH, 0.38, Hand Threading 9/16-18 LH, 0.56, Hand Threading	80146 80147 80148
Guide Bushing 0.25, Hand Threading 0.38, Hand Threading 0.56, Hand Threading	80149 80150 80151

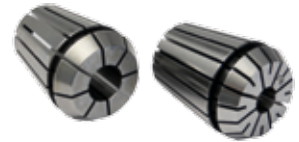

* Available on request







Miscellaneous Parts & Supplies



LP WATER FILTER COMPONENTS

DESCRIPTION	PART No.	
<p> Filter Element, LP Water, 10.0 long, polypropylene 10 micron</p> <hr/> <p>40 micron</p>	<p>10106722</p> <hr/> <p>10100782</p>	
<p> Filter Element, LP Water 10 micron, 20.0 long, polypropylene Used on all SL-VI (PRO) units</p>	<p>72125264</p>	
<p> Filter Element, LP Water 10 micron, 20.0 long, polypropylene Used on all SL-V, PRO-I and PRO-2 units</p>	<p>49834716</p>	
<p> Filter Housing Assembly - LP Water, 0.75 FNPT connections, stainless steel, manual relief valve Uses Part Number 49834716 Filter Element Replaces Part #05038690</p>	<p>72118339</p>	
<p> Filter Strainer, 50 NPTF, 40 Mesh, polypropylene</p>	<p>20412815</p>	

HYDRAULIC OIL FILTER COMPONENTS

<p> Hydraulic, 6 micron, 4.0 long, spin on For 15 to 60 horsepower units</p>	<p>05049689</p>	
<p> Hydraulic, 10 micron, 9.40 long, spin on For 75 to 200 horsepower units</p>	<p>05104187</p>	

* Available on request

O-RINGS FOR SEALING HEADS

DESCRIPTION

PART No.

- O-Ring - 131, 1.69 x 1.88 x 0.09, Buna-N, D-70**
 Used on all PRO-I units,
 Used on sealing head 20480113 (p. 18)
- O-Ring, Metric, 3MM x 1XX, Buna-N, D-70**
 Used on SL-IV units
 Used on sealing head 05116769 (p. 19)

10146082

05049853



O-RINGS FOR PNEUMATIC VALVES

- O-Ring - 035, 2.25 x 2.38 x 0.06, Viton, D-75**
 Used on all 4,100 and 6,200 bar
 N/O pneumatic actuator assemblies (p. 44)
- O-Ring - 143, 2.44 x 2.63 x 0.09, Viton, D-75**
 Used on all 4,100 and 6,200 bar
 N/O pneumatic actuator assemblies (p. 44)
- O-Ring - 038, 2.63 x 2.75 x 0.06, Viton, D-70**
 Used on all 4,100 and 6,200 bar
 N/C pneumatic actuator assemblies (p. 44)
- O-Ring - 044, 0.08 x 0.20 x 0.06, Viton, D-75**
 Used on all 4,100 and 6,200 bar
 N/C pneumatic valve assemblies (p. 44)

10074565

10074714







10177806

49895584



DESCRIPTION

PART No.

-  **O-Ring - 344, 3.88 x 4.25 x 0.19, Buna-N, D-90A**
Used on all PRO-III units
Used on hydraulic cylinder head
-  **O-Ring - 115, 0.69 x 0.88 x 0.09, Buna-N, D-70**
Used on the proximity switch of all PRO units
-  **O-Ring - 218, 1.25 x 1.50 x 0.13, Polyurethane, D-70**
Used on all hydraulic piston assemblies (p. 13)
-  **O-Ring - 252, 5.25 x 0.5 x 0.13, Viton, D-75**
Used on all SL-V and SL-VI (PRO) units with a 75 (PRO: 60) to 200 horsepower rating
Used on hydraulic cylinder head
-  **O-Ring - 132, 1.75 x 1.94 x 0.09, Buna-N, D-70**
Used on all SL-V, SL-VI and NL-I units
O-Ring for LP water inlet
-  **O-Ring - 214, 1.0 x 1.25 x 0.13, Buna-N, D-70**
Used on all OEM 50 units and all SL-V and NL-I units with a 15 to 60 horsepower rating
Used on intensifier support

72176756



05144191



05087713



10074771

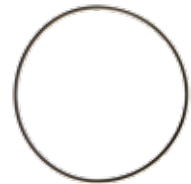

10074920



10074409



O-RINGS FOR TOPWORKS

DESCRIPTION

PART No.

- **O-Ring - 240, 3.75 x 4.0 x 0.13, Buna-N, D-70**
Used on all SL-IV, SL-V, SL-VI and NL-I units with a 15 to 60 horsepower rating
Used on hydraulic cylinder head

10075000









- **O-Ring - 129, 1.56 x 1.75 x 0.09, Buna-N, D-70**
Used on all SL-IV units
O-Ring for LP water inlet

10074904

O-RINGS FOR CUTTING HEADS

DESCRIPTION

PART No.

-  **O-Ring - 012, 0.38 x 0.50 x 0.06, Buna-N, D-70**
Used on wear insert for AUTOLINE PRO cutting head assemblies
-  **O-Ring - 011, 0.31 x 0.44 x 0.06, Aflas, D-70**
AUTOLINE II & AUTOLINE PRO cutting head assemblies
Used in wear insert 20453064 (p. 32)
-  **O-Ring - 018, 0.75 x 0.88, Polyurethane, D-70**
AUTOLINE PRO cutting head assemblies
Used in cap 20480732 (p. 31)
-  **O-Ring, 0.69 x 0.81 x 0.06**
AUTOLINE II & AUTOLINE PRO cutting head assemblies
Used in nozzle body 20480715 & 20453958 (p. 31)
-  **O-Ring - 013, 0.44 x 0.56 x 0.06, Buna-N, D-70**
Used on Abrasive Inlet Adapter
Used on IDE II & IDE PRO cutting heads
-  **O-Ring - 012, 0.38 x 0.50 x 0.06, Polyurethane, D-70**
Used on AUTOLINE I & AUTOLINE II cutting head assemblies
Used in cap 20453952 & 05076971 (p. 31)
-  **O-Ring - 016, 0.63 x 0.75 x 0.06, Polyurethane, D-70**
Used on AUTOLINE I cutting head assemblies
Used in nozzle body 05073820 (p. 31)
-  **O-Ring - 014, 0.50 x 0.63 x 0.06, Polyurethane, D-70**
Used on AUTOLINE I cutting head assemblies

05077078



20445476



05142286



05138821



10074870



05081518



05092887



05104930



* Available on request

O-RINGS FOR INLINE FILTERS

DESCRIPTION

PART No.

- **O-Ring - 012, 0.38 x 0.50 x 0.06, Viton, D-75**
 Used in 49893555 Filter Assembly (p. 65)

10074599



BOOSTER PUMPS

Booster Pump, Stainless Steel, CW ROT

- 14 bar, 1.33 gpm
 Used on PRO units with a 60 horsepower rating
- 8 bar, 3.13 gpm
 Used on all SL-V and PRO units with a 75 to 125 horsepower rating
- 14 bar, 1.33 gpm
 Used on all SL-V units with a 15 to 60 horsepower rating
- 14 bar, 1.33 gpm
 Used on all SL-V units with a 15 to 60 horsepower rating and temperature probe

20481206

49836778

49887094

05071659



HOSES

- ■ **Polyurethane Tubing - 0.38, Clear**
- ■ **Push-on Hose - 0.50, 20 bar, Blue**
- ■ **PVC Tubing - 0.50 x 0.748, Reinforced, Static-free**
- ■ **Flexible Tubing - 0.50, Nylon**

49885361

20421272

05076963*

05044532



DESCRIPTION

PART No.

Pressure Gauge - 0-10,300 bar
 0.38 HP, Flush Mount, 6" Face, Glycerin filled
 For use on 6,200 bar pumps
 Requires 20464745 Adapter

20467883



Pressure Gauge - 0-14 bar
 0.25 NPT, back mount, Stainless Steel

05139506



Pressure Gauge - 0-350 bar
 0.25 bottom mount
 For 0.88 plungers, SL-IV and SL-V

05045497



Pressure Gauge - 0-6,900 bar
 0.25 HP, 4.25" Face, bottom mount
 For use on 4,100 bar pumps

20443831



Pressure Gauge - 0-6,900 bar
 0.25 HP, Bottom Mount
 6" Face, Glycerin filled
 For use on 4,100 bar pumps

05125836

PROXIMITY SWITCH KITS

4,100/6,200 bar, 75-200 horsepower
 Used on all 1-1/8" plunger topworks
 Used on all 6,200 bar PRO units

20453925

















E50, 3,800/4,100 bar
 Used on all SL-IV, SL-V, Classic and OEM units
 with a 15 to 60 horsepower rating
Replaces Part #05127584

20453934



* Available on request

ELECTRICAL COMPONENTS

DESCRIPTION	PART No.	
 Solenoid Valve - 24V DC 5,4 W 8,5 W, for AQUALINE Cutting Head	49888035 05450127	
 Output Module - Single Point, 24V DC, 3 amp	10146363	
 Inlet Pressure Switch, 2 bar, Stainless Steel	05140751	
 Valve Proportional Pressure Control	80071087	
 Proportional Control Assembly Kit Including Valve (80071087) and installation material	05121987	
 Directional Control Valve - Electric, 24V DC, D03, 4-way	05017553	
 Directional Control Valve Assembly, 24V DC, D08, 0.055 orifice For SL-IV & SL-V 30, 50, 60 horsepower intensifiers	20437164	
 Knob Adjuster Used on all Hydraulic Cartridge Valve Assemblies Pressure Relief, 1.7-207 bar, SL-V, Classic and OEM units	10187052	
 Water Modulating Valve	10091866	

LIGHT BULBS

DESCRIPTION

PART No.

 **Light Bulb 24V**
For use with Klockner Moeller Switches

05050216



 **Light Bulb 24V AC/DC**
For AB 800F

20484737



PRESSURE TRANSDUCERS

 **UHP Pressure Transducer**
0-6,200 bar

20478335



 **Pressure Transducer**
0-5,200 bar

49838478



 **PICO Fuse**

49885866



DESCRIPTION	PART No.	
 Hydraulic Tensioner Assembly, PRO Intensifier 6,200 bar	20476132	
 Cylinder Clamp, PRO Intensifier 6,200 bar	20476495	
 Vee Block Cradle	20484961	
HP Seal Removal Tool		
 0.88 Plunger, 4,100/6,200 bar	10148674	
 1.13 Plunger, 4,100 bar	05146618	
Plunger Removal Tool		
 0.88 Plunger, 4,100/6,200 bar	20477460	
 1.13 Plunger, 4,100 bar	20477469	
 Plate Glass Pane 8.0 x 8.0 x 0.25	10149052	
 Emery Cloth 320 Grit, 9.0 x 11.0 400 Grit, 9.0 x 11.0 600 Grit, 9.0 x 11.0	10149029	
	10149037	
	10149045	

DESCRIPTION

- **Cylinder Wrench**
4,100 bar
- **Crowfoot Wrench**
1.625, 0.38 drive
- **HP Seal Removal Tool Stand**
4,100 bar
- **End Cap Wrench**
4,100 bar , 6x/8x, HSEC

PART No.

05066139

20477489

80078330

80079239



LUBRICANTS

DESCRIPTION

PART No.

 **Pure Goop Thread Lubricant**
1.0 pound

05026281



 **Pure Goop Thread Lubricant**
1.0 ounce

10084440



 **NLGI-2 Swivel Grease**
14.0 ounce

10067189



 **FML-2 Grease - FDA Approved**
14.5 ounce

10087385



 **Super-O-Lube O-Ring Grease**
0.07 ounce

20485968

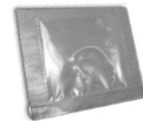

 **Threadlocker Adhesive**
242, 0.50 ML

20487868



 **Threadlocker Primer**
1.75 ounce

20494983



 **JL-M Thread Lubricant**
16.0 ounce

49832199



 **JL-M Thread Lubricant**
15 ML

80082191



KMT Offices Worldwide

Main Office Germany (Bad Nauheim)

KMT GmbH
Phone: +49-6032-997-150

Main Office USA (Baxter Springs)

KMT Waterjet Systems Inc.
Phone: +1-620-856 2151

Main Office China (Shanghai)

KMT Machine Tool Ltd.
Phone: +86-21-50 48 46 21

Office Spain (Madrid)

KMT Waterjet Systems S.L.
Phone: +34-91-510 37 98

Office UK (Birmingham)

KMT Waterjet Systems
Phone: +44-1384-408 892

Office Russia (Moscow)

KMT Waterjet LLC
Phone: +7-495-665 02 52

Office France (Lissieu)

KMT Waterjet France SARL
Phone: +33-4-78 22 69 45

Office Poland (Warsaw)

KMT Sp. z o.o.
Phone: +48-22-545 06 60

Office U.A.E. (Dubai)

KMT Waterjet Systems
Phone: +971-4-701 79 66

Office Italy (Milan)

KMT Italia SRL
Phone: +39-02-642 21 801

Office Sweden (Ronneby)

KMT Waterjet Systems
Phone: +46-708-32 45 20

Office India (Mumbai)

Karolin Machine Tools Pvt Ltd.
Phone: +91-22-285 724 94

Global Service Around The Corner



Index

Item #	page	Item #	page	Item #	page	Item #	page
80125	68	05045497	84	05108816	74	05122742	74
80126	69	05049689	78	05108824	74	05122759	74
80129	68	05049853	79	05108832	73	05123385	7
80130	69	05049994	13	05108840	73	05125836	84
80142	76	05050216	86	05108857	73	05130091	13
80143	76	05051891	43	05108865	74	05130927	43
80144	76	05054119	51	05108873	74	05131347	58
80145	75	05059688	16	05108881	74	05132253	14
80146	76	05059712	16	05108899	75	05133335	25
80147	76	05063847	42	05108915	75	05135827	34
80148	76	05066139	88	05108964	75	05136031	53
80149	76	05069703	46	05108972	75	05136098	42
80150	76	05071659	83	05109079	42	05138821	82
80151	76	05073820	33	05109814	74	05139506	84
80152	76	05075999	65	05109822	74	05140751	85
80175	75	05076955	34	05109830	74	05142286	82
80217	42	05076963	83	05109871	73	05144191	80
80220	42	05076971	33	05109889	73	05144357	22
80225	42	05076989	35	05109897	73	05144506	11
80227	42	05077029	42	05110531	66	05144514	10
80230	42	05077037	42	05112057	57	05144597	23
80235	42	05077078	82	05112537	42	05144688	21
80240	42	05077300	42	05114137	67	05144696	23
80245	42	05077367	34	05114897	42	05145099	17
80386	75	05078530	30	05114905	42	05146576	14
80387	75	05078712	35	05114921	42	05146584	13
80388	75	05081518	82	05115951	8	05146618	87
80389	75	05084504	42	05115977	8	05146964	47
80423	42	05086905	58	05116009	72	05149703	7
80433	42	05087168	35	05116017	47	05149711	7
05007786	17	05087713	80	05116025	47	05210174	75
05013735	53	05092887	82	05116595	23	05214794	42
05017553	85	05097928	43	05116652	43	05218652	64
05024641	68	05097936	43	05116769	21	05221943	8
05026281	89	05097944	43	05116777	23	05221951	8
05027172	8	05101753	42	05117528	43	05222836	42
05034764	10	05104187	78	05117940	14	05225470	50
05034772	10	05104930	82	05117965	14	05225488	50
05034798	17	05108741	74	05119151	11	05225496	50
05034855	13	05108774	74	05120092	13	05450127	49 85
05039771	11	05108782	74	05120258	74	10067189	89
05044375	67	05108790	74	05121512	42	10069326	57
05044532	83	05108808	74	05121987	85	10074409	80

Item #	page	Item #	page	Item #	page	Item #	page
10074565	79	10079523	63	10138485	54	20417000	21 22
10074599	83	10079531	59	10138493	54	20417081	21
10074714	79	10079580	61	10138501	54	20421272	83
10074771	80	10079614	59	10138519	54	20422243	7
10074870	82	10079655	61	10138527	54	20422970	58
10074920	80	10083897	58	10138535	54	20422988	58
10075000	81	10084440	89	10138584	53	20427648	48
10077030	51	10084713	70	10138592	53	20427739	46
10078038	60	10087385	89	10138600	53	20427747	25
10078129	62	10090280	57	10138618	53	20436198	39
10078145	59	10091866	85	10138634	53	20437164	85
10078244	63	10093573	62	10138642	53	20439964	75
10078301	75	10094175	57	10138659	53	20442434	34
10078426	61	10094183	57	10138667	54	20443831	84
10078459	62	10094191	57	10138675	54	20445476	82
10078509	62	10094647	71	10138683	54	20448625	42
10078525	59	10094704	57	10138691	54	20451227	43
10078590	60	10096139	65	10138709	54	20452309	43
10078608	62	10097228	60	10138717	54	20452956	62
10078640	59	10100782	78	10138725	54	20452959	61
10078699	62	10102226	51	10138824	46	20452962	62
10078715	61	10103018	57	10146082	79	20452965	61
10078749	64	10105443	57	10146363	85	20452968	60
10078772	63	10105880	57	10148674	87	20452971	60
10078780	59	10106417	22	10149029	87	20453064	34
10078863	63	10106722	78	10149037	87	20453082	34
10078889	63	10110393	23	10149045	87	20453115	60
10078905	59	10116333	62	10149052	87	20453121	62
10078913	62	10119030	64	10154680	71	20453124	61
10079002	64	10126928	43	10177806	79	20453127	63
10079028	59	10126936	43	10177855	49	20453130	63
10079051	59	10126969	43	10181105	54	20453136	63
10079119	61	10134682	68	10181113	53	20453553	66
10079168	60	10134690	70	10184760	46	20453925	9 84
10079259	63	10134708	69	10186153	58	20453934	9 84
10079275	64	10134716	68	10187052	85	20453949	30
10079291	62	10138402	53	10187250	50	20453952	33
10079424	61	10138410	53	10189181	48	20453958	33
10079432	61	10138428	53	10189553	49	20453964	35
10079457	61	10138436	53	10193100	54	20453973	35
10079465	60	10138444	53	20412815	78	20453976	35
10079473	61	10138451	53	20414880	10	20454108	30
10079481	60	10138469	53	20416445	10	20454129	34

Item #	page	Item #	page	Item #	page	Item #	page
20454198	73	20477382	43	20481412	29	20487868	89
20454201	73	20477386	43	20481413	29	20487975	56
20454339	34	20477395	43	20481414	29	20488720	72
20454342	36	20477460	87	20481415	29	20489074	54
20454345	36	20477469	87	20481416	29	20489092	54
20454351	51	20477489	88	20481418	29	20489107	56
20454354	46	20477505	24	20481607	41	20489115	56
20454363	36	20477518	47	20481609	41	20489495	25
20454366	36	20477521	47	20481613	41	20489761	56
20454426	36	20477619	65	20481660	23	20490760	43
20455329	54	20477623	69	20481704	38	20490768	43
20455374	60	20477660	59	20481705	38	20490843	69
20455377	59	20477685	59	20481706	38	20490851	69
20455809	59	20477709	59	20481707	38	20490859	70
20455812	60	20477730	59	20481708	38	20491098	68
20455821	59	20477738	59	20481709	38	20491603	12
20455824	60	20477836	64	20481710	38	20492123	17
20455911	65	20478335	86	20481711	38	20493999	56
20456913	66	20478649	56	20481712	38	20494983	89
20458242	34	20478751	56	20481713	38	20496208	41
20464647	54	20478993	50	20481714	38	20496210	41
20467135	7	20479022	49	20481715	38	20496211	41
20467883	84	20479499	7	20481716	38	20496212	41
20467981	63	20479524	22	20481717	38	20496214	41
20468014	63	20479589	34	20481718	38	20496215	41
20468568	63	20480087	20	20481719	38	20497106	52
20468593	64	20480113	20	20481720	38	20497767	12
20468610	64	20480359	46	20481721	38	20498314	17
20468617	48	20480707	29	20481722	38	49830904	51
20468634	46	20480715	33	20484737	86	49832199	89
20468830	56	20480732	33	20484961	87	49832678	62
20470475	48	20480940	67	20485968	89	49832801	61
20474154	49	20480977	54	20486133	43	49833593	43
20474333	12	20480993	50	20486151	43	49834716	78
20475871	48	20481005	20	20486158	43	49835390	43
20475882	50	20481009	22	20486166	43	49836778	83
20475916	67	20481026	67	20486952	69	49836786	39
20475944	67	20481206	83	20486976	68	49837206	61
20475956	70	20481407	29	20487002	71	49838478	86
20476132	87	20481408	29	20487241	52	49862261	66
20476495	87	20481409	29	20487249	52	49863574	39
20477023	59	20481410	29	20487257	52	49863582	39
20477366	43	20481411	29	20487273	52	49863590	39

Item #	page	Item #	page	Item #	page	Item #	page
49863608	39	72113373	22	80070352	17	20477959011	29
49863616	39	72113680	40	80070519	57	20477959012	29
49863624	39	72113688	40	80071087	85	20477959013	29
49863632	39	72117819	24	80073646	16	20477959014	29
49863665	50	72118339	78	80073885	65	20477959016	29
49863715	67	72119529	16	80074057	25	20477959018	29
49865405	50	72119536	15	80074446	54	A22593	53
49865850	39	72119544	15	80075252	43	A22594	53
49885361	83	72120023	16	80075781	42	A22595	53
49885866	86	72121850	15	80077795	48	A22596	53
49887094	83	72121858	15	80078330	88	A225910	53
49888035	49 85	72122072	62	80079239	88	A225911	53
49888852	39	72125203	25	80082191	89	A225912	53
49888860	39	72125264	78	80084403	24	A2259800	53
49888878	39	72129713	72	80085079	8	A2260003	39
49888886	39	72132350	40	80086622	13	A2260011	39
49888894	39	72132358	40	80086663	42	A2260013	39
49888902	39	72133175	61	80086671	42	A2260015	39
49888910	39	72133183	61	91954073	39	A2260016	39
49888928	39	72133209	61	91959122	69	A2260018	39
49888936	39	72133224	61	91959130	68	A2260019	39
49888944	39	72133232	61	91959627	70	A2260020	39
49888951	39	72133250	61	91959635	70	A2260022	39
49888969	39	72133266	62	91959643	68		
49888977	39	72133349	62	91959650	71		
49888985	39	72135447	24	91959668	69		
49888993	39	72136231	40	20477950007	30		
49893555	67	72136249	40	20477950008	30		
49894249	51	72136256	40	20477950009	30		
49894272	66	72138164	11	20477950010	30		
49895584	79	72141569	9	20477950011	30		
49899602	69	72142526	20	20477950012	30		
72101354	54	72146433	9	20477950013	30		
72103361	56	72154588	15	20477950014	30		
72103379	56	72154603	20	20477950016	30		
72103386	56	72158494	7	20477950018	30		
72103535	56	72160831	15	20477959007	29		
72103733	56	72162253	11	20477959008	29		
72104402	56	72163802	12	20477959009	29		
72108319	56	72166738	15	20477959010	29		
72110945	12	72168337	8				
72110961	22	72170157	20				
72110979	20	72176756	80				

Please note that all technical details shown in this catalog are subject to change and pictures are similar.



KMT GmbH • KMT Waterjet Systems

Hohe Straße 4-6 • 61231 Bad Nauheim • Germany
Phone: +49-6032-997-0 • Fax: +49-6032-997-270
www.kmt-waterjet.com • info@kmt-waterjet.com

KMT Waterjet Systems Inc.

635 West 12th Street
Baxter Springs • KS 66713 • USA
Phone: +1-620-856-2151

KMT Machine Tool Ltd.

No. 251 Ri Ying Nan Road • WaiGaoQiao Free Trade Zone
Shanghai, 200131 • China
Phone: +86-21-5048-4621